



ASSEMBLY INSTRUCTIONS

Double Deep Wine Cellar Kits (All Models)

Questions?
Toll free 1-888-373-6057 or visit WineRacksAmerica.com



Thank you and CONGRATULATIONS for purchasing this quality product. Properly assembled, your racking collection will beautifully enhance your wine collection for many years to come. To assemble, please check to ensure all necessary parts are included and follow the assembly instructions closely. If you have any questions or problems please call customer service toll free 1-888-373-6057 Monday through Friday 7:00 am - 5:00pm MST.



Planning to stain?
For best results we recommend you stain or finish your racking BEFORE assembly.

Tools For Assembly:

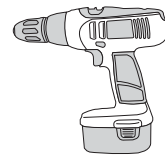

Cordless Drill

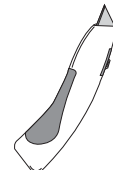

Utility Knife

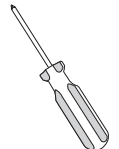

Screwdriver



Finish Nailer

OR

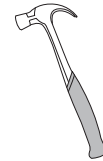

Hammer

+



Nail Setter



The instructions pictured are for a 6 column double deep rack. Follow the same steps for all double deep wine cellar racks, regardless of model.

PARTS LIST

PARTS ARE NOT TO SCALE

END LADDER ASSEMBLIES

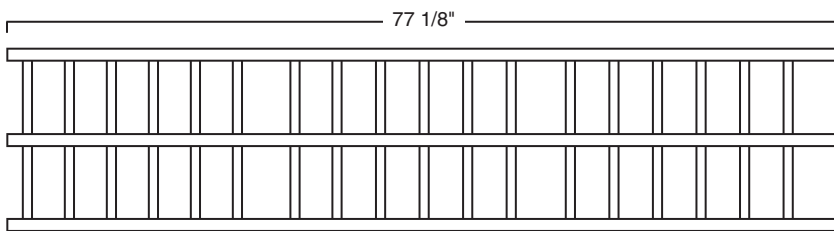

SIDE VIEW



MIDDLE LADDER ASSEMBLIES

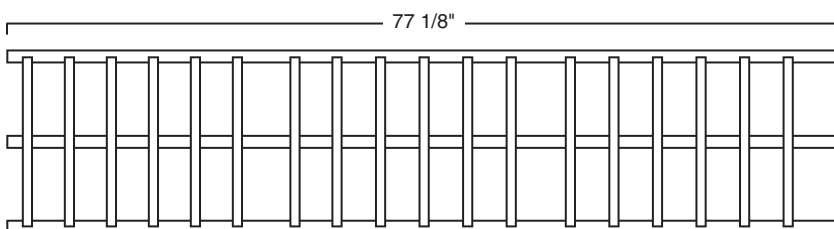

SIDE VIEW

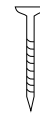

1 1/4" WOOD SCREWS



FINISH NAILS

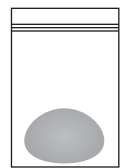

SMALL BAG OF WOOD PUTTY

STANDARD COLUMN CONNECTORS (Various Lengths)

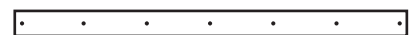

SIDE VIEW



SCREWLESS COLUMN CONNECTORS (Various Lengths)



SIDE VIEW



PACKAGE CONTENTS

* Please verify that you have the correct number of parts before proceeding. Depending on the model you purchased, your bundle should contain the following:

RACK	MIDDLE LADDERS	END LADDERS	STANDARD CONNECTORS	SCREWLESS CONNECTORS	1 1/4" SCREWS	FINISH NAILS
10 column	9	2	(6) 10 column	(2) 10 column	66	22
9 column	8	2	(6) 9 column	(2) 9 column	60	20
8 column	7	2	(6) 8 column	(2) 8 column	54	18
7 column	6	2	(6) 7 column	(2) 7 column	48	16
6 column	5	2	(6) 6 column	(2) 6 column	42	14
5 column	4	2	(6) 5 column	(2) 5 column	36	12
4 column	3	2	(6) 4 column	(2) 4 column	30	10
3 column	2	2	(6) 3 column	(2) 3 column	24	8
2 column	1	2	(6) 2 column	(2) 2 column	18	6
1 column	0	2	(6) 1 column	(2) 1 column	12	4

* All models follow the same assembly procedure - varying only in the number of middle ladders your rack will require.

* PLEASE FOLLOW WRITTEN INSTRUCTIONS CAREFULLY

1. Find an open, flat area in which to work. Carefully remove all components from the box and remove banding with a utility knife. Check the parts list to verify package contents
2. Arrange the end ladders on the floor so that the bottle support pieces face one another. Align the large gaps on each end ladder. **The end with the larger gap is the top of your rack.** Attach a standard column connector to the top and bottom of your rack using the 1 1/4" screws provided. Make sure the connectors are flush with the top and bottom of your rack. (figure 1)

* Minimize the risk of splitting your ladders by drilling a 1/16" pilot hole before driving the wood screws. For best results, drive the screw most of the way in with your drill, then finish tightening by hand.

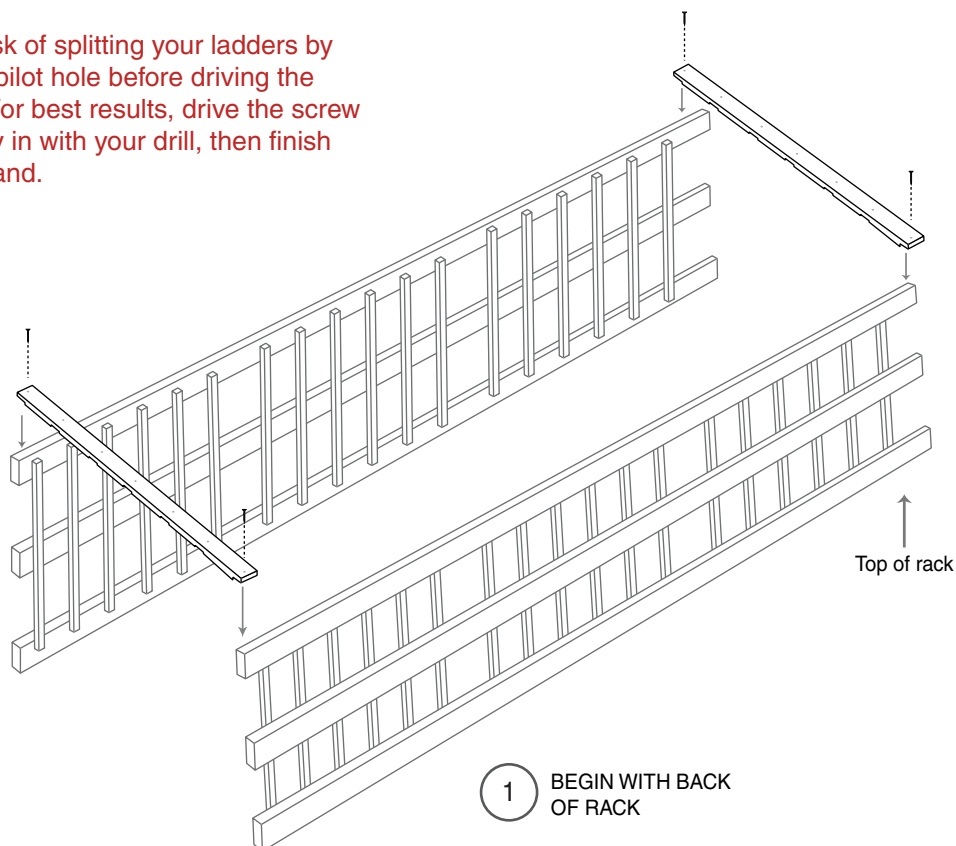

3. Insert the middle ladders and finish securing the top & bottom connectors using the 1 1/4" screws provided.
4. Attach the middle standard connectors so that the top edge of the lower connector is 26 11/16" from the bottom of the rack, and the top edge of the upper connector is 51 11/16" from the bottom of the rack. Secure the middle connectors using the 1 1/4" screws provided. **This is the back of your rack.** (figure 2)

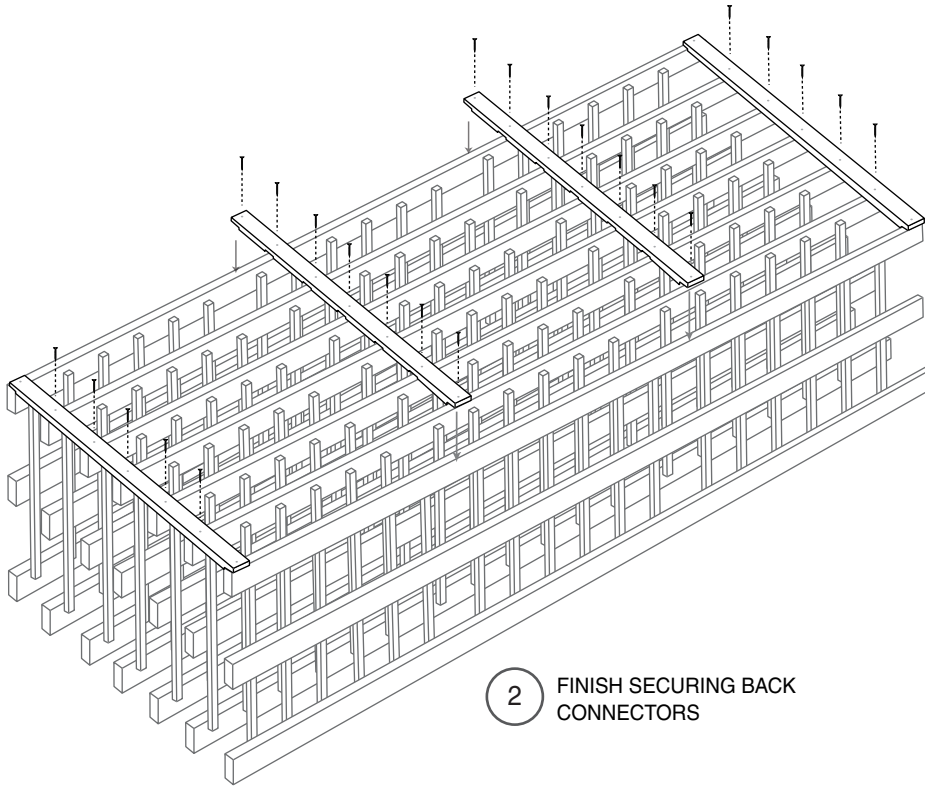

2 FINISH SECURING BACK CONNECTORS

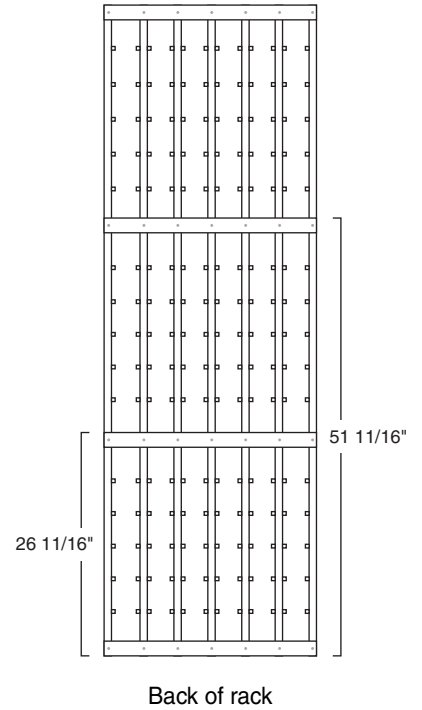

-
5. Flip rack over and secure a standard column connector to the top and bottom of your rack using the 1 1/4" screws provided. (figure 3)

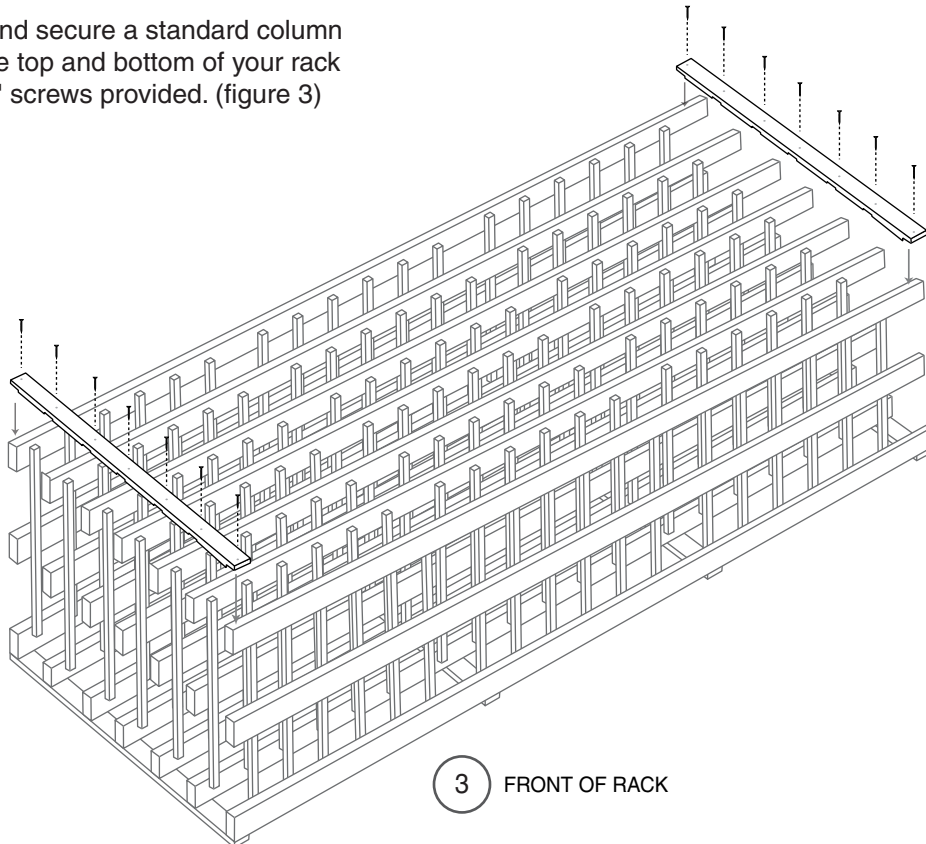

3 FRONT OF RACK

6. Attach the middle screwless connectors so that the top edge of the lower connector is 26 11/16" from the bottom of the rack, and the top edge of the upper connector is 51 11/16" from the bottom of the rack. Make sure the rack is flat on the floor while attaching the screwless connectors. (figure 4)

Secure the screwless connectors using a finish nail gun to drive a finish nail through the connector into each vertical ladder. (figure 5)

If you do not have a finish nail gun, drive one of the provided finish nails into each vertical ladder until it is flush. Then, countersink the nail using a nail setter until the head of the nail is about 1/16" below the surface of the wood.

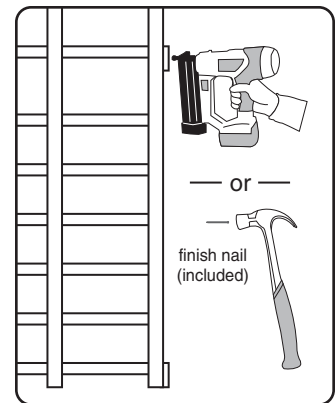
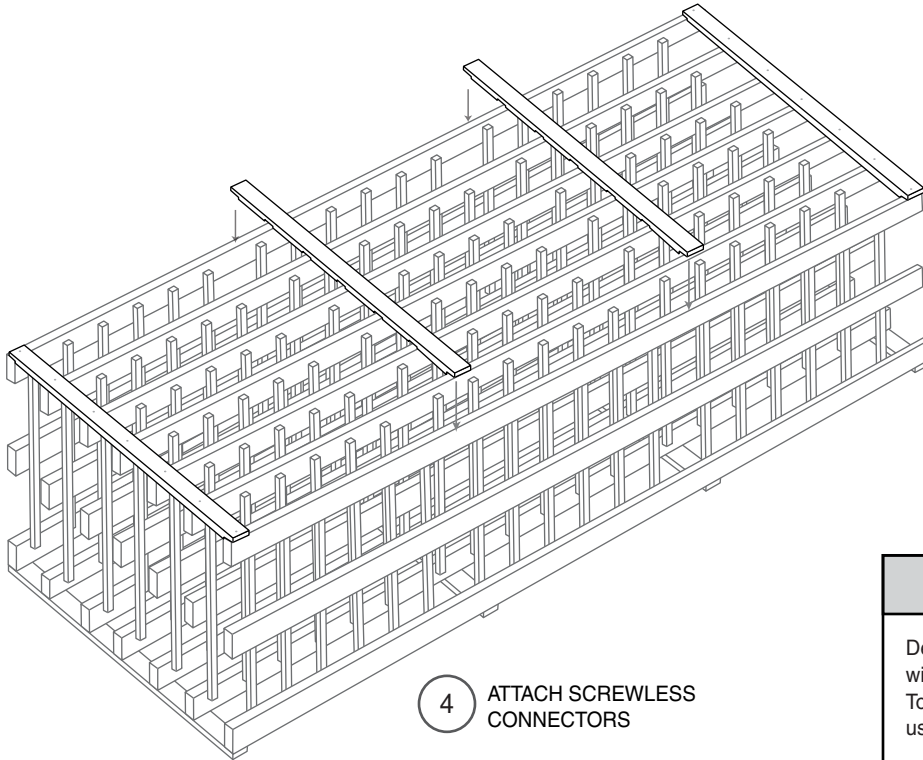

7. Fill the nail holes using the wood putty provided. Simply push the putty into each hole using your thumb and wipe excess putty off the surface using a damp cloth.
8. That's it! Enjoy this beautiful rack with your favorite beverage. Pair with other rack styles for an ultimate cellar storage look.

Attaching your rack to the wall:

Depending on how many bottles you store, your wine cellar rack could weigh as much as 600 lbs. To avoid tipping attach your racking to the wall using one of the following methods.

1. Put the rack in the desired location.
2. Shim the front of the rack so it is even with the back wall.
3. Locate a wall stud behind the rack.
4. Drive a 2 1/2" wood screw through a back connector to attach to the stud.

- OR -

1. Use "L" brackets (located at any hardware store).
2. Attach to both the rack and the wall in any out of the way spot.



WINE RACKS AMERICA

360 N 700 W suite F • North Salt Lake, UT 84054
 (toll free) 888-373-6057
 (fax) 801-936-0534

WineRacksAmerica.com

Once again thank you for your business. Remember, customer service is available to answer your questions M-F 7:00 am - 5:00 pm MST. Please feel free to contact us for any wine storage need.