



# ASSEMBLY INSTRUCTIONS

## Standard Tasting Table Racks

WRATT640, WRATTBB640 - Pine

WRATT641, WRATTBB641 - Redwood

Questions?

Toll free 1-888-373-6057 or visit [WineRacksAmerica.com](http://WineRacksAmerica.com)



Thank you and CONGRATULATIONS for purchasing this quality product. Properly assembled, your racking will beautifully enhance your wine collection for many years to come. To assemble, please check to ensure all necessary parts are included and follow the assembly instructions closely. If you have any questions or problems please call customer service toll free 1-888-373-6057 Monday through Friday 7:00 am - 5:00pm MST.



### Planning to stain?

For best results we recommend you stain or finish your racking BEFORE assembly.

### Tools For Assembly:

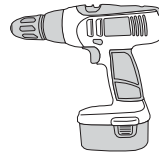

Cordless Drill



Utility Knife

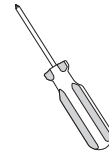

Screwdriver



Wood Glue

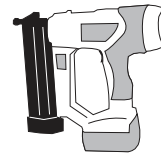

Finish Nailer

OR



Hammer

+



Nail Setter



The instructions pictured are for the WRATTBB640 rack. Follow the same steps for all standard single depth Tasting Tables, regardless of model.

## PARTS LIST

PARTS ARE NOT TO SCALE

SIDE LADDER ASSEMBLY x 2

MIDDLE LADDER ASSEMBLY x 7

BUTCHER BLOCK TOP x 1  
(depending on model)

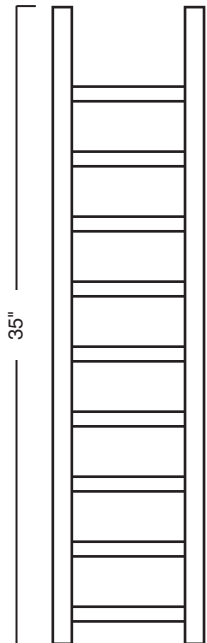

Front View

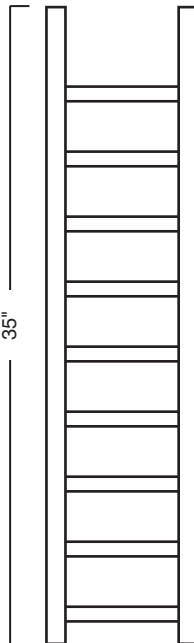

Front View



1 1/4" WOOD SCREWS x 18



FINISH NAILS x 18



SMALL BAG OF WOOD PUTTY

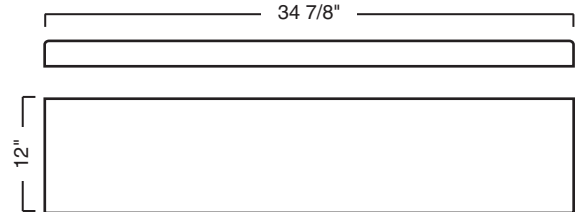

Top View

STANDARD COLUMN CONNECTORS x 2

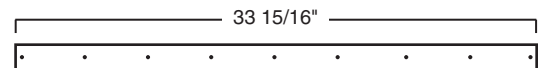

SIDE VIEW

SCREWLESS COLUMN CONNECTORS x 2

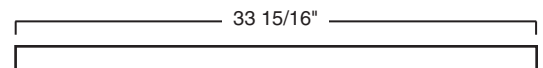

SIDE VIEW

1. Find an open, flat area in which to work. Carefully remove all components from the box and remove banding with a utility knife. Check the parts list to verify package contents.

2. Arrange the side ladders on the floor so that the bottle support pieces face one another. Align the large gaps on each side ladder. **The end with the larger gap is the top of your rack.** Attach a standard column connector to the top and bottom of your rack using the 1 1/4" screws provided. Make sure the connectors are flush with the top and bottom of your rack. (figure 1)

\* Minimize the risk of splitting your side ladders by drilling a 1/16" pilot hole before driving the wood screws. For best results, drive the screw most of the way in with your drill, then finish tightening by hand.

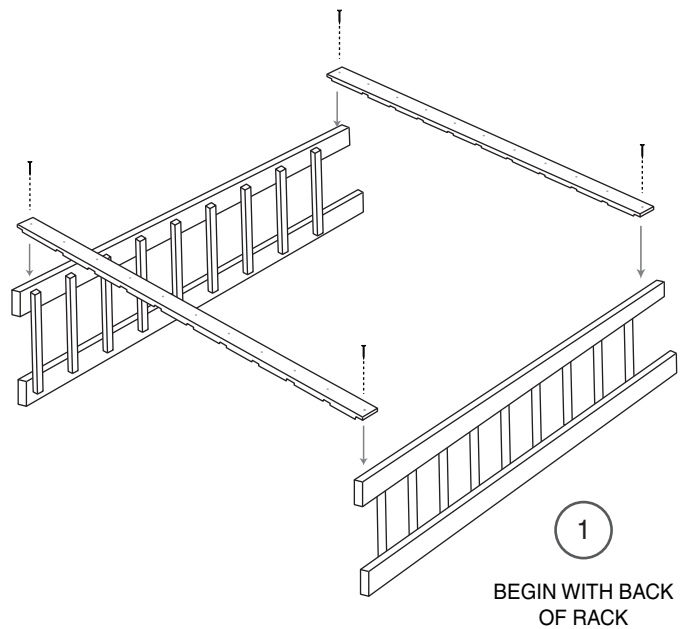

3. Insert the middle ladders and finish securing the top and **bottom connectors using the 1 1/4" screws provided. This will be the back of your rack.** (figure 2)

4. Flip rack over and attach two screwless column connectors to the front of your rack. The upper connector should be flush with the top of the rack and the lower connector should be flush with the bottom of the rack. Make sure the rack is flat on the floor while attaching the screwless connectors. (figure 3)

Secure the screwless connectors using a finish nail gun to drive a finish nail through the connector into each vertical ladder. (figure 4)

If you do not have a finish nail gun, drive one of the provided finish nails into each vertical ladder until it is flush. Then, countersink the nail using a nail setter until the head of the nail is about 1/16" below the surface of the wood.

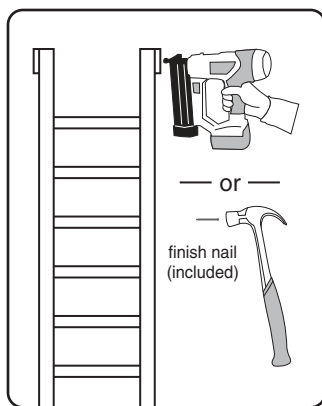
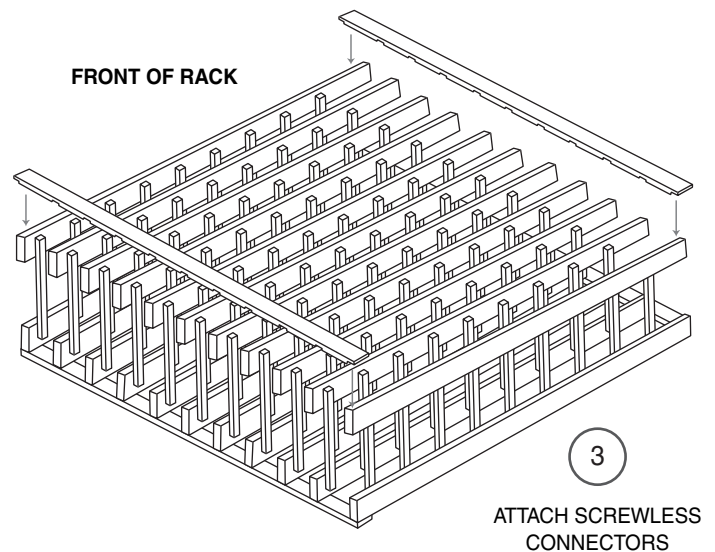
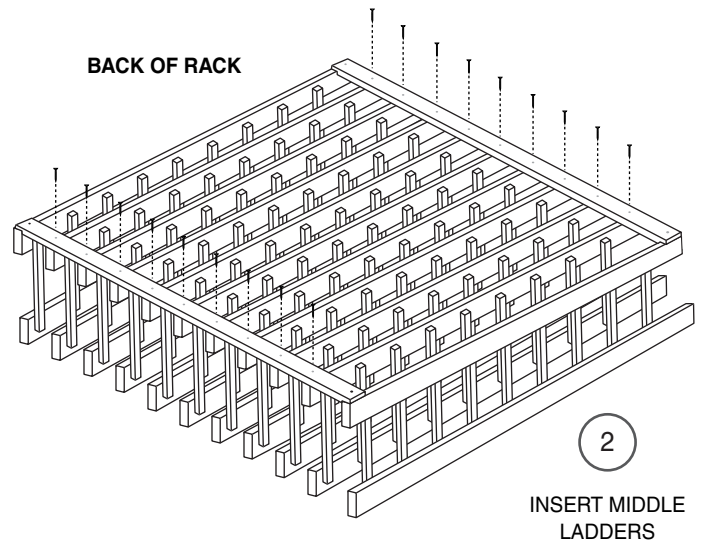

4 SECURE WITH FINISH NAILS

5. Fill the nail holes using the wood putty provided. Simply push the putty into each hole using your thumb and wipe excess putty off the surface using a damp cloth.
6. Stand the rack upright. If you purchased a Standard Tasting Table Base your assembly is complete. (figure 5)

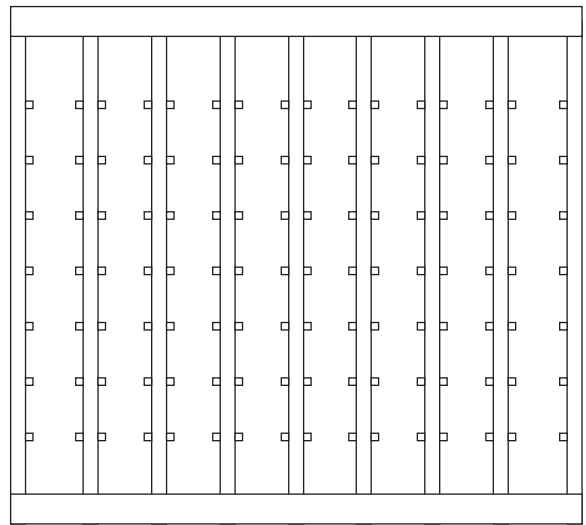

5 STAND RACK UPRIGHT

### 7. Tasting Table Top

If you ordered the Standard Tasting Table with the butcher block top, secure it by placing a small amount of wood glue on the tops of the ladders and clamping the butcher block to the table base using standard wood clamps. Allow glue to fully dry before removing clamps. (figure 6)

8. That's it! Enjoy this beautiful rack with your favorite beverage. Pair with other rack styles for an ultimate cellar storage look.

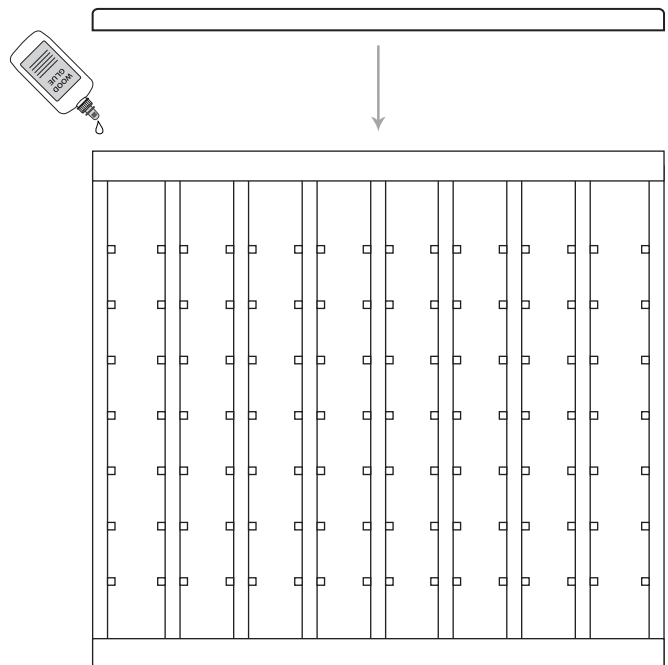

6 SECURE BUTCHER BLOCK TOP



**WINE RACKS AMERICA**

360 N 700 W suite F • North Salt Lake, UT 84054  
 (toll free) 888-373-6057  
 (fax) 801-936-0534

WineRacksAmerica.com

Thank you for your business. Remember, customer service is available to answer your questions M-F 7:00 am - 5:00 pm MST. Please feel free to contact us for any wine storage need.